

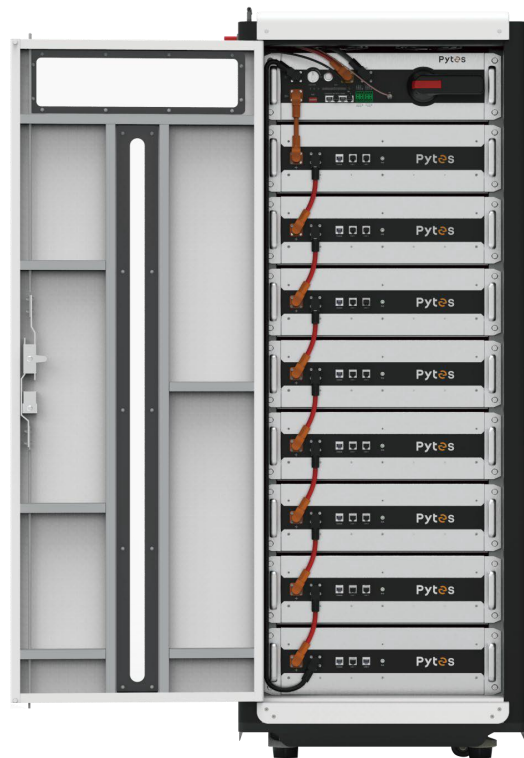

Installation and configuration manual With Deye

Pytes Lithium Battery HV48100

With Deye Inverter

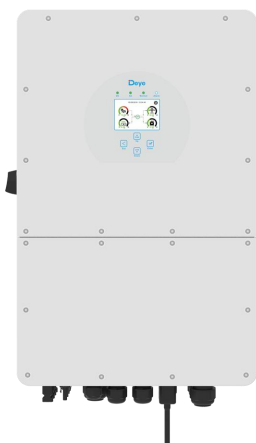

WARNING:

HV48100 is a high voltage DC system and must be operated by authorized person only.

Warning

Before connecting

- 1) Please check products and components according to enclosed packing list after unpacking. Please contact PYTES if there is any damage or missing of products and / or components.
- 2) Make sure power sources are cut off and battery system is powered off before installation.
- 3) Wiring correctly by identifying positive and negative cables to ensure no short circuit with external devices.
- 4) It is forbidden to connect the battery directly with AC power.
- 5) Battery system must be well grounding and the resistance must be less than 0.1Ω ; _
- 6) Make sure the electrical parameters of battery system are compatible with related equipment.;
- 7) Keep the battery away from water and fire.

In Operation

- 1) Battery must be physically powered off in case of any move or repair.
- 2) It is forbidden to connect HV48100 to other types of battery;
- 3) It is forbidden to connect the battery to a faulty or incompatible inverter;
- 4) It is forbidden to disassemble the battery (QC label removed or damaged);
- 5) In case of fire, only dry powder fire extinguisher can be used, liquid fire extinguishers are prohibited ;
- 6) Please do not open, repair or disassemble the battery other than staffs from Pytes or authorized by Pytes. Pytes do not undertake any consequences or related responsibility caused by violation of safety operation or design, production and equipment safety standards;

Caution

- 1) Please read this manual carefully before installation and any operation.
- 2) Charge the battery every 6 months to keep battery SOC > 90% if long term storage.
- 3) Battery must be charged within 12 hours when low voltage alarm triggered.
- 4) Battery DC output voltage exceeds 48V. It is vital to pay attention to personal safety in any case when operating.
- 5) All battery terminals must be disconnected before maintenance.
- 6) Please contact with Pytes within 24 hours if there is anything abnormal.
- 7) Battery being damaged directly or indirectly by above cases will result in warranty failure.

Note :This part only includes the battery and inverter installation part.

Please refer to other documents for the battery installation part.

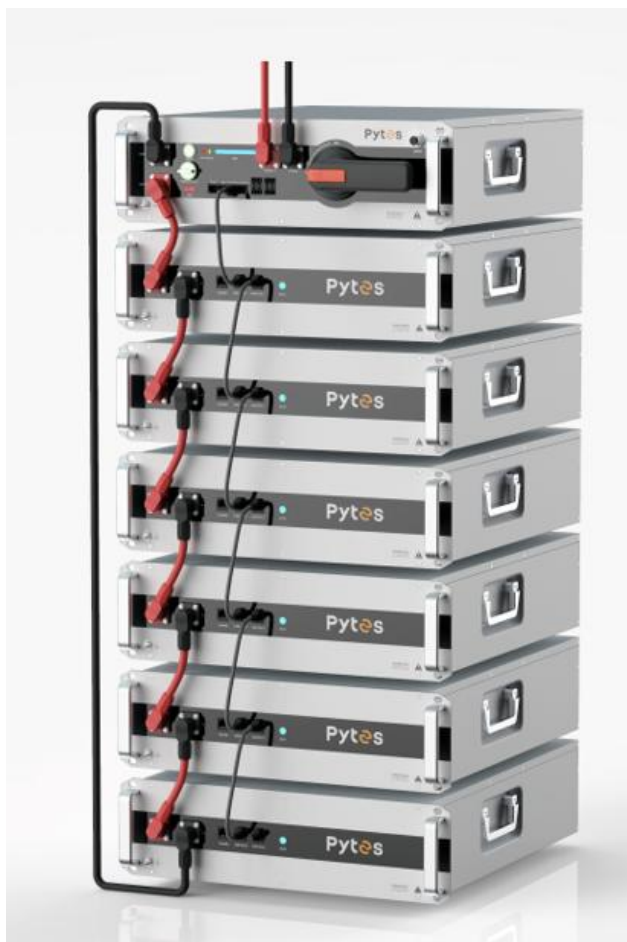
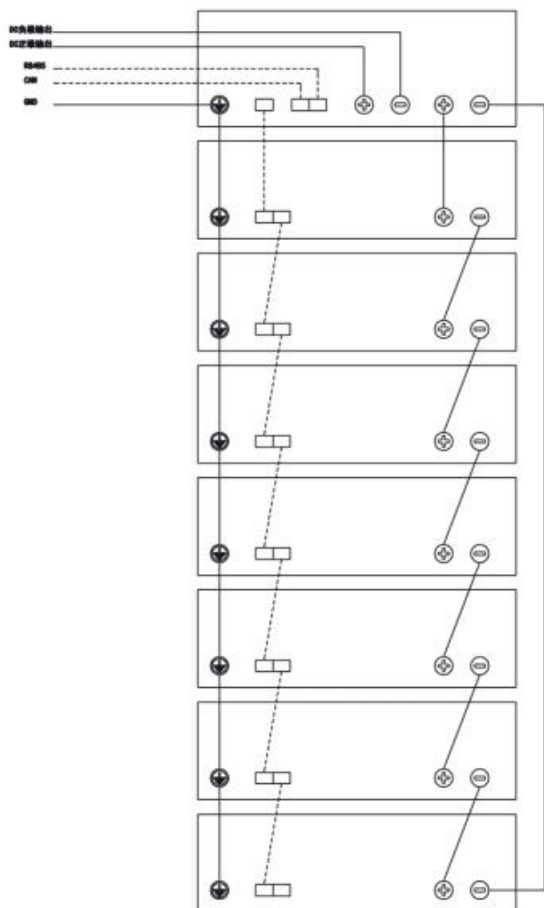

CONTENTS

BOM LIST 3

1. Communication Cable Connection 8

2. Power Cable Connection 9

3. Set The DIP Switch 11

4. Start up the system 12









5. Change the battery setting of the inverter 16

6. Check the battery soc 17

7. System monitoring 19

Prepare tools for installation

Wear the safety gears listed in the installation manual at all time.

		
Wire Cutter	Crimping Modular Plier	Cable Ties
		
Screw Driver Set	Electric Screw Driver	Insulating Gloves
		
Adjustable Wrench	1500VDC Isolating nut drivers	2000VDC Multimeter

It is recommended to wear the following safety gears when dealing with the system.



绝缘手套



安全护目镜



安全鞋

BOM LIST

Before installation, you should prepare following items.

Item	Remarks	Quantity
Power Cable (DC)	<input type="checkbox"/> Cable diameters: 4awg(≥ 25 mm) <input type="checkbox"/> Only copper cables may be used. <input type="checkbox"/> The DC cables must be sized for the maximum battery voltage and the maximum battery current (see battery manufacturer documentation).	1pair
Earthing cable		1
Com. Cable	CAN communication or RS485 communication	1
Battery	HV48100 series	Depends on the number of Battery module
Inverter	Deye	1

Definition of RJ45 Port Pin for BMS is as follow. **CAN port** definition

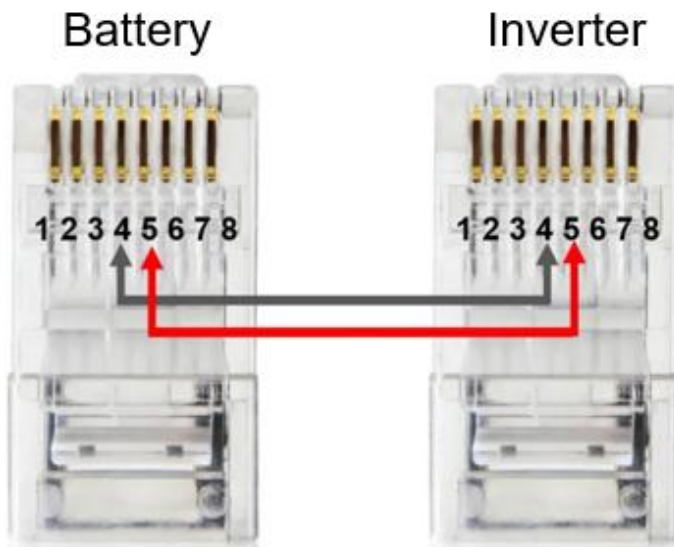

HOW TO INSATLL

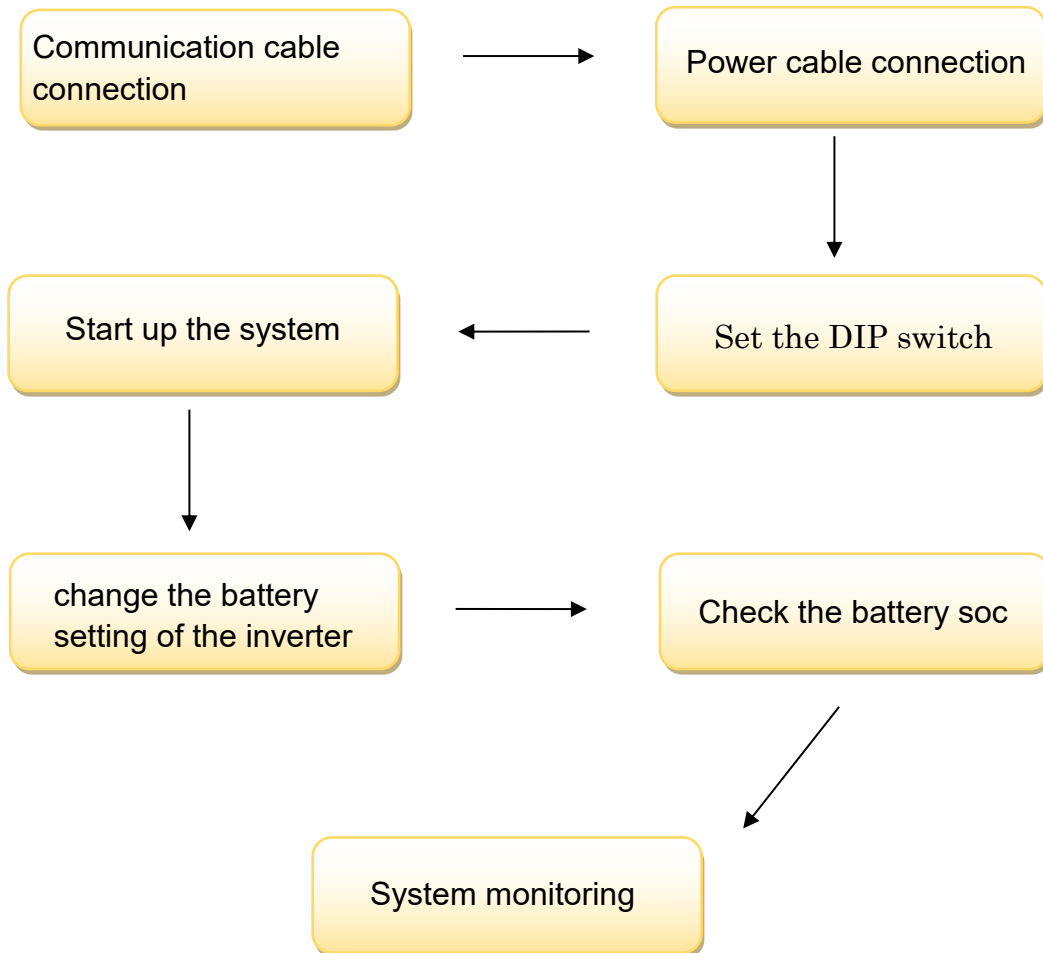

CAUTION: If you want to get more inverter-related settings, please refer to the inverter user manual first.

1. Communication Cable Connection

Connect the end of the cable to the inverter communication port as shown in pic 1.1.1. Make sure use **BMS1** port.

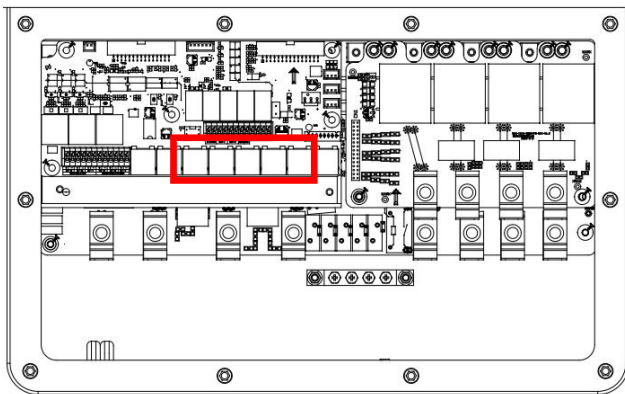

Meter: for energy meter communication.
Parallel_1: Parallel communication port 1.
Parallel_2: Parallel communication port 2 .
CAN: reserved.
DRM: Logic interface for AS/ NZS 4777.2:2020.
BMS1: BMS port for battery communication port 1.
BMS2: BMS port for battery communication port 2.
RS485: RS485 port.

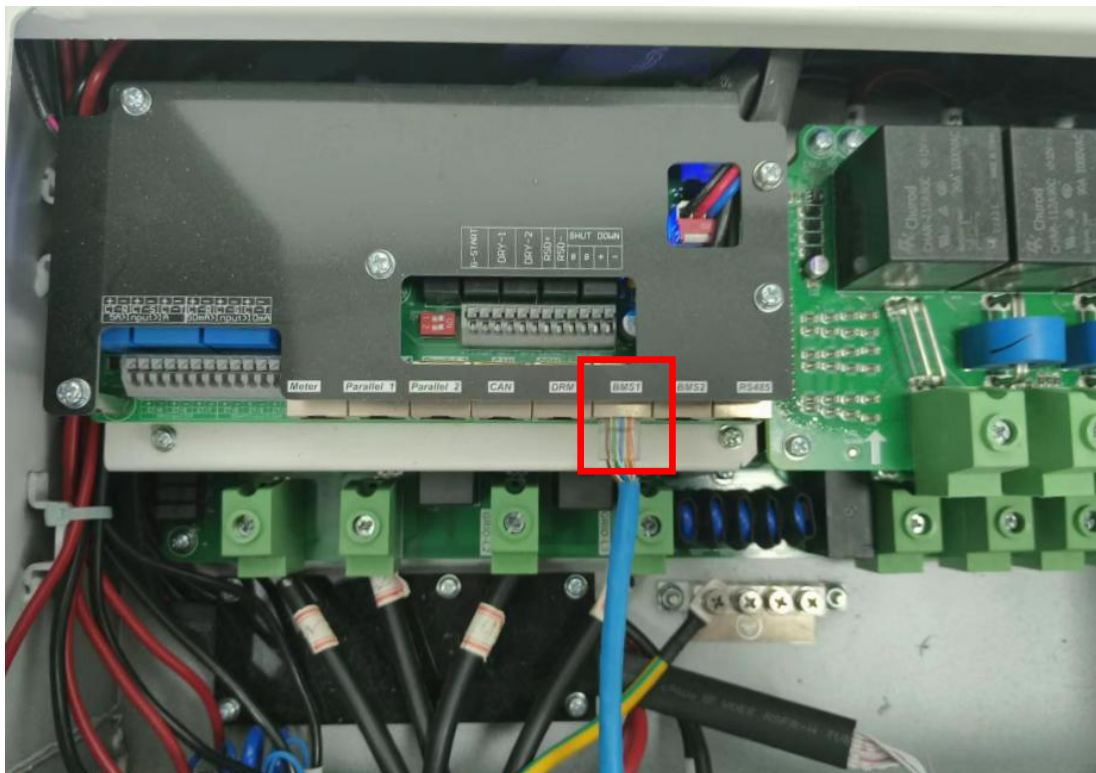

Pic 1.1.1

Connect the other end of the cable to the BCUs **CAN** port as shown in pic 1.1.2. (Ensure the correct sequence of communication cable)

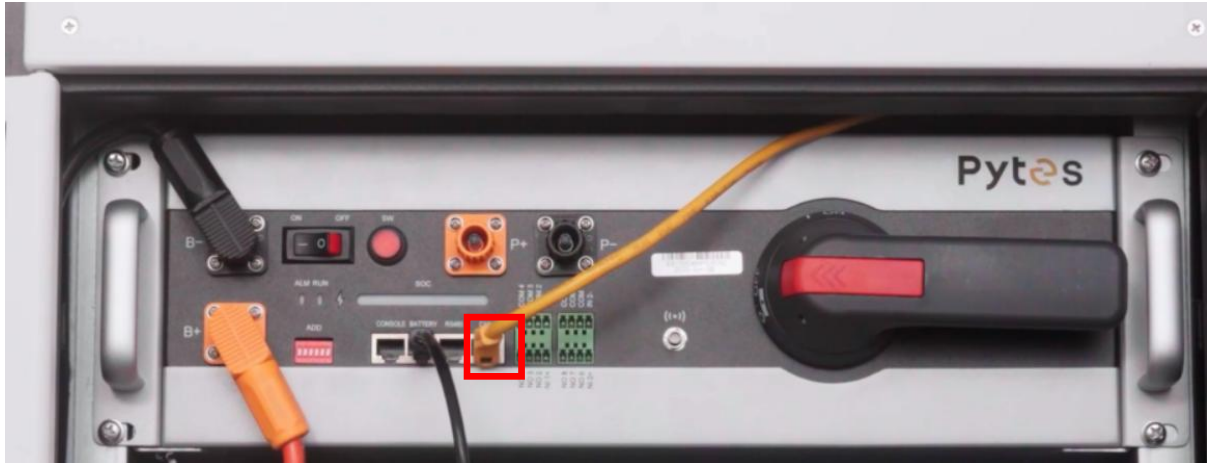

Pic 1.1.2

2. Power Cable Connection

Step.1

Insert the red cable into the positive DC connector ,Insert black cable into negative DC connector as shown in Pic 1.2.1.

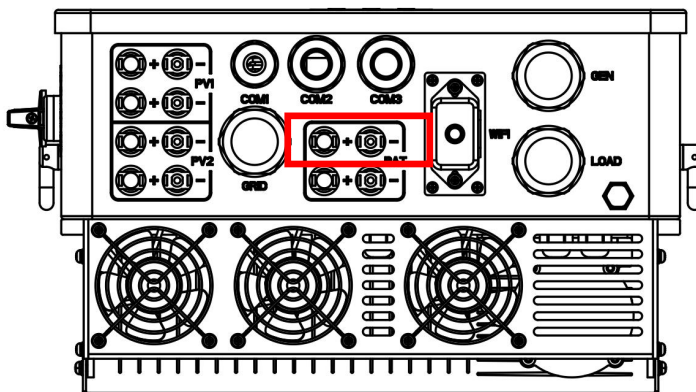

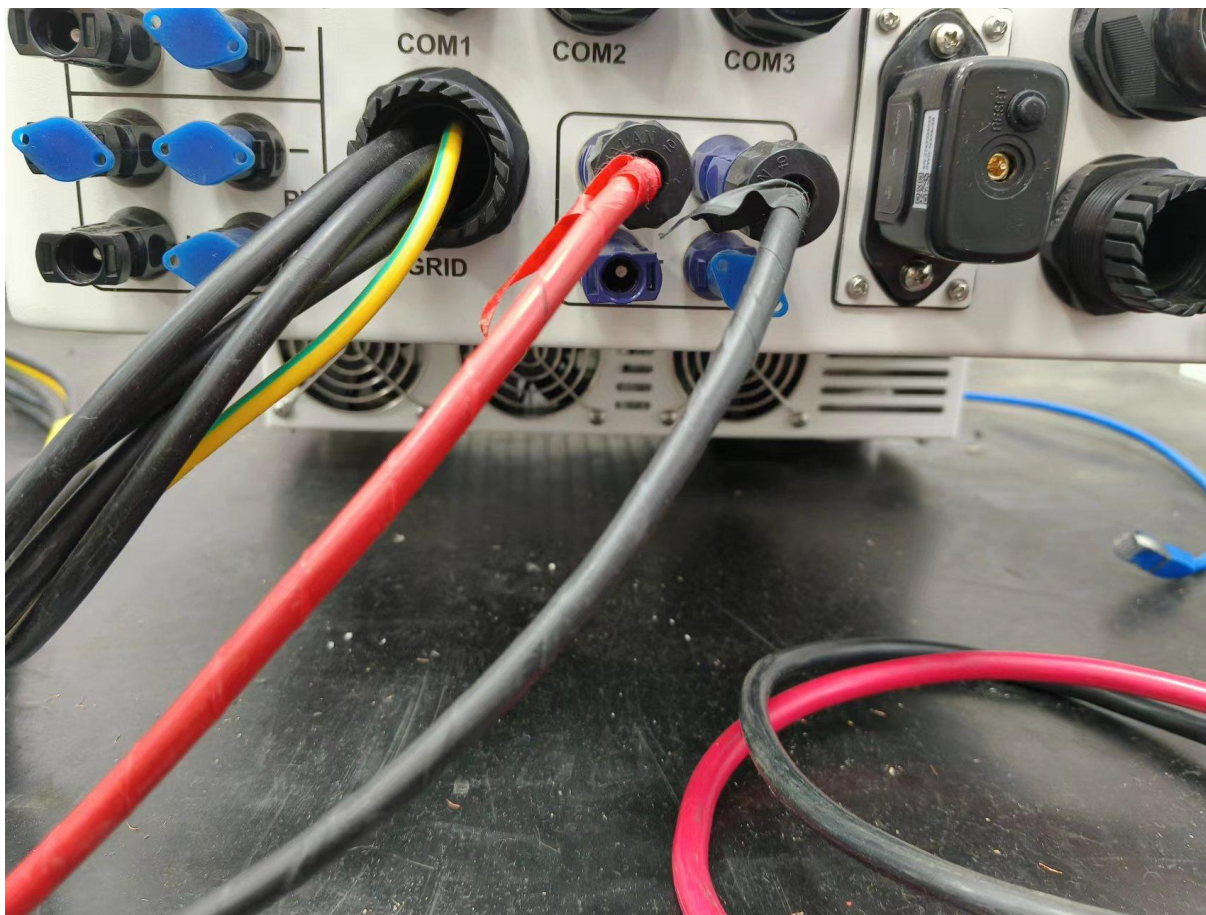

Pic 1.2.1

Step.2

At the other end of the cable, connect to the battery as shown Pic 1.2.2. (Ensure that the battery power switch is off)



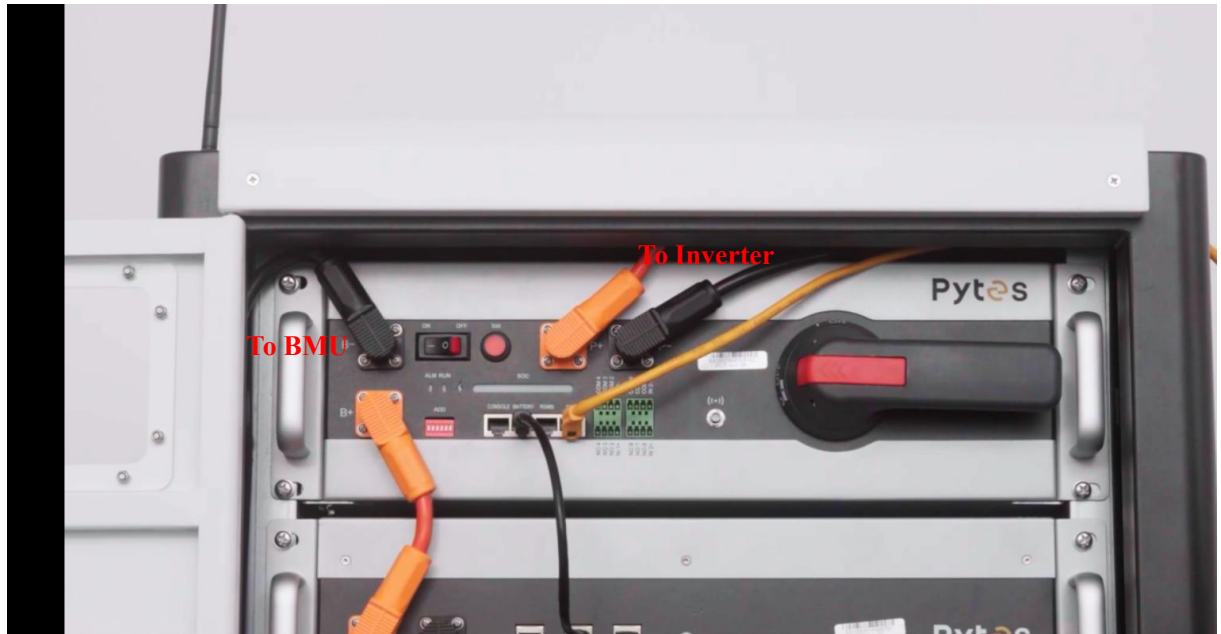

Pic 1.2.2

3. Set The DIP Switch

Before set the DIP switch,make sure the isolation switch is in the off state.



Pic 1.3.1

Then set the DIP switch of BCUs as shown in Pic 1.3.2.

Deye



Down, up, down, down, down, down

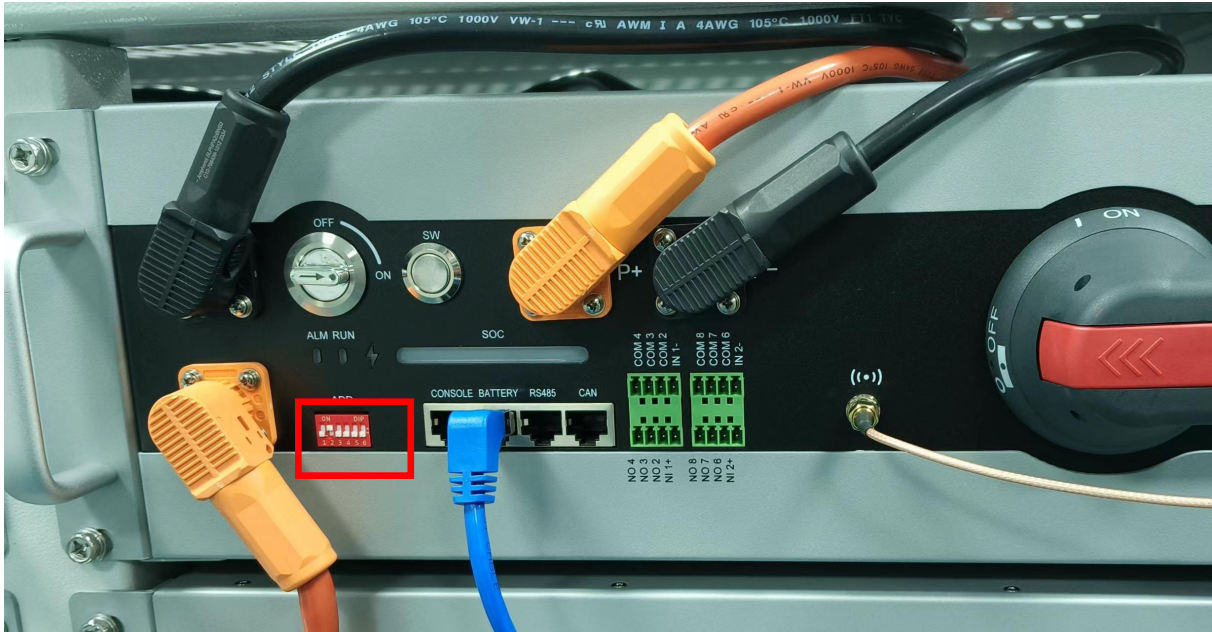

Pic 1.3.2

4. Start up the system

Before start up the inverters and batteries, make sure the wires are connected correctly.



Step.1 Turn on the isolation switch.

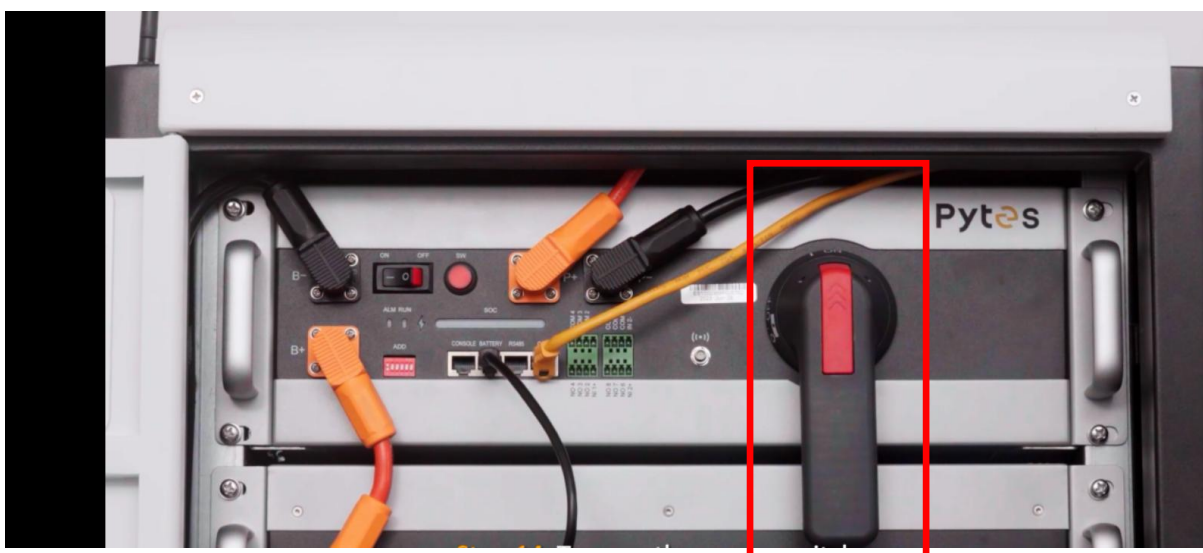
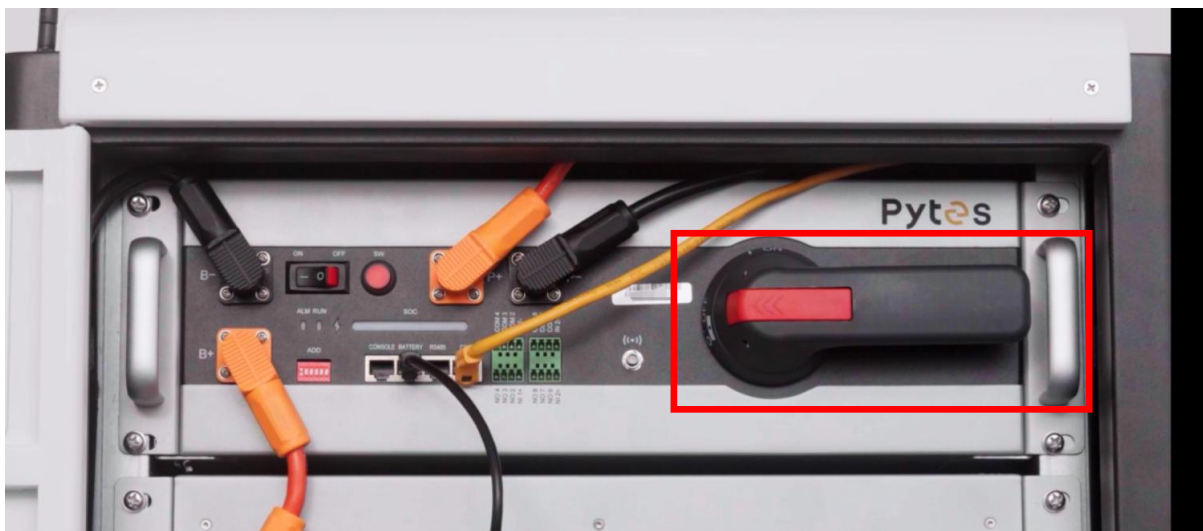

Pic 1.4.1

Step.2 Turn on the power switch .





Pic 1.4.2

Step.3 Short press the red **SW** button, the RUN light on main control will flicker.

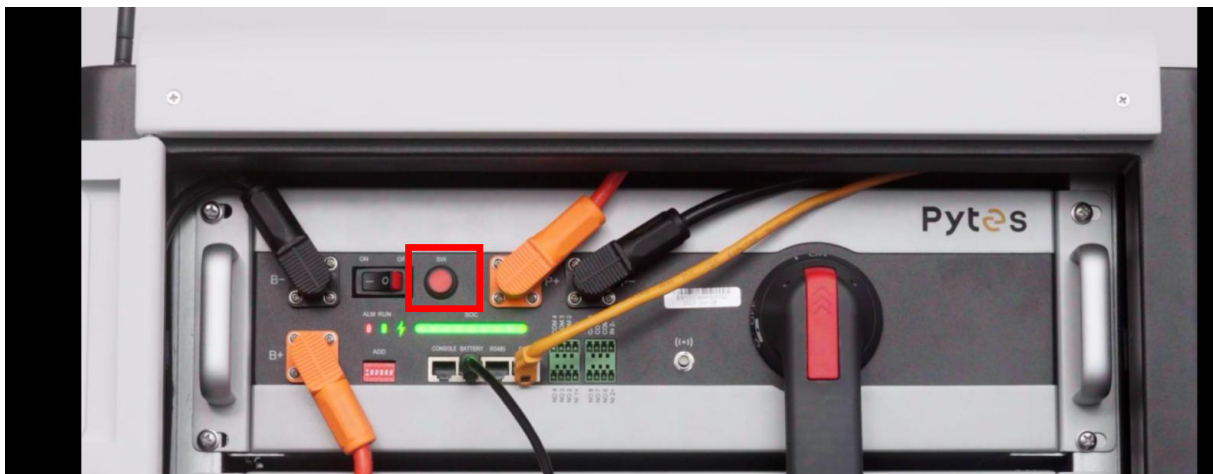

Step.4 Press the inverter button, start the inverter.

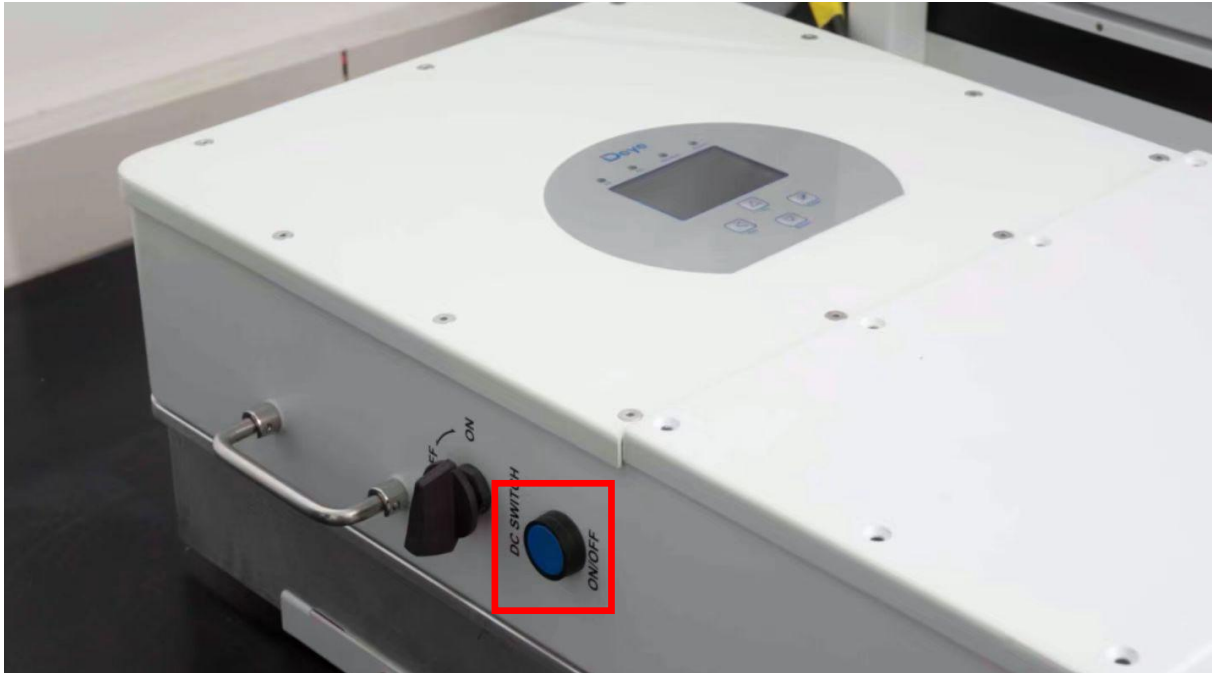

5.Change the battery setting of the inverter

※CAUTION:If you want more details about the batteries settings , please check the operating manual of inverters.

Step1.

Change the battery type to lithium in the Battery setting.

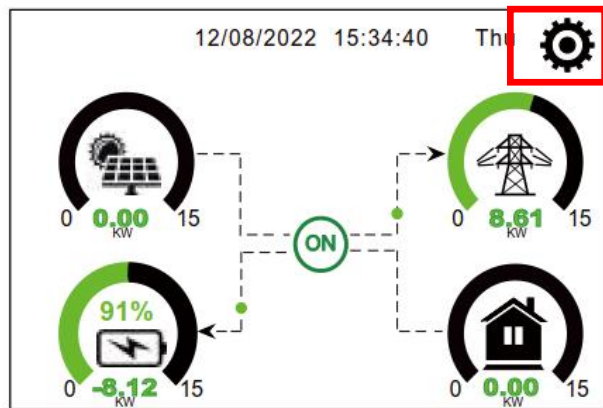

Pic 5.1.1

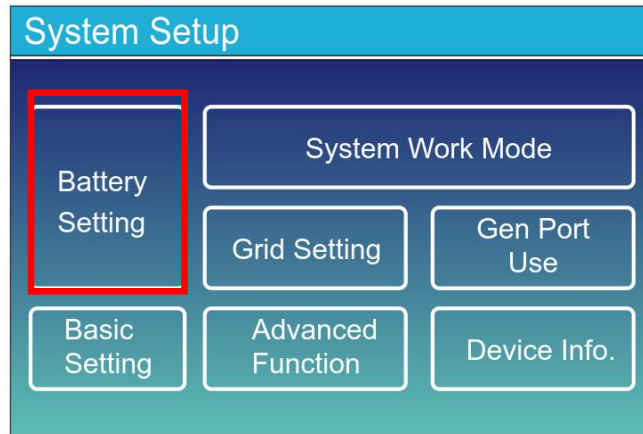

Pic 5.1.2

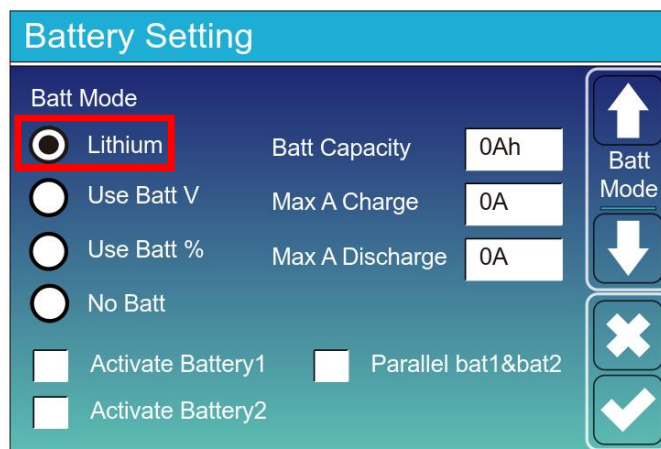

Pic 5.1.3

Step2.

Turn to the next page, use CAN communication, set the lithium mode to 00 .touch ✓ to confirm

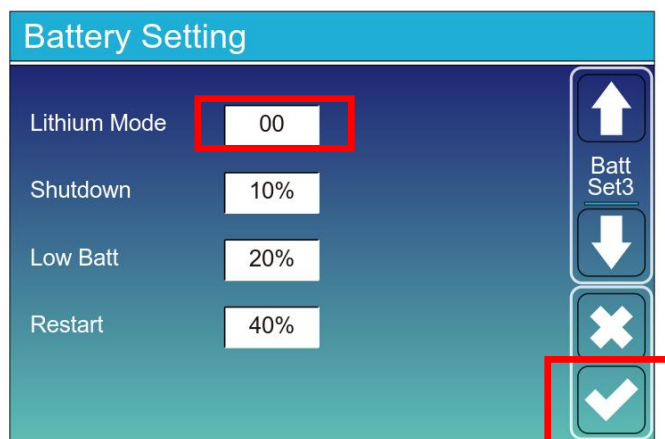

Pic 5.2.1

6. Check the battery soc

Step.1

Touch the battery icon of the inverter's touch panel.

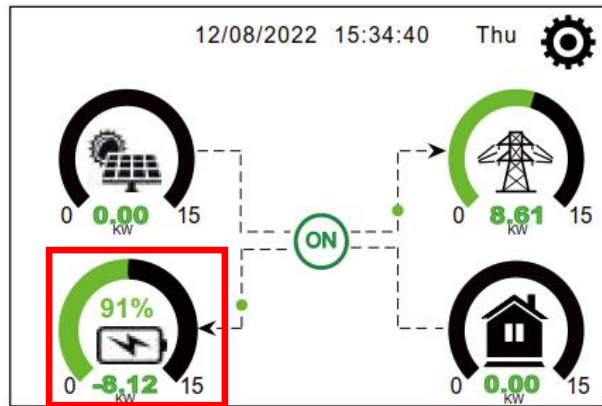

Pic 6.1.1

Step.2

Click the Li-BMS in battery information page.

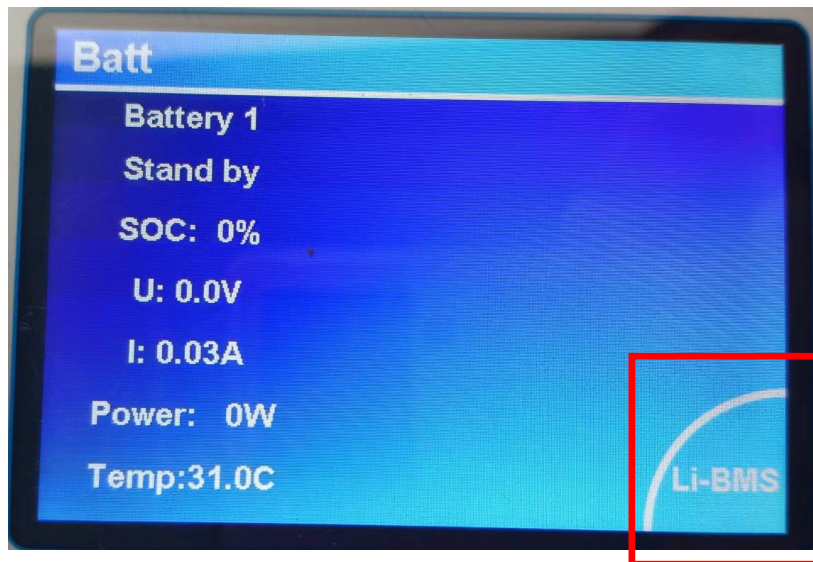

Pic 6.1.2

The details of the battery will be shown on the parameter if the connection between battery and inverter is correct.

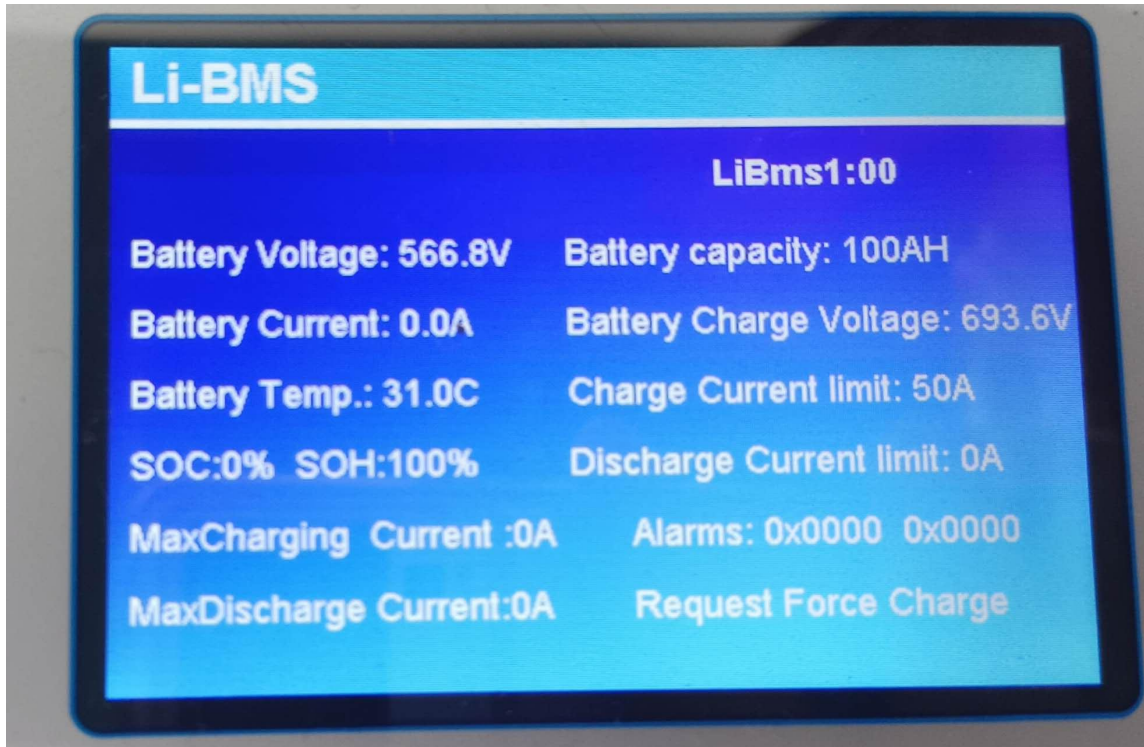

Pic 6.1.3

7. System monitoring

※ **CAUTION:** If you want more details about system monitoring, please check the operating manual of inverters.

Download the app from the app store.



Pic 7.1.2

Register a new account and create a new plant.

-END-